

**5<sup>th</sup> Annual Stockholders' Meeting  
of ThyssenKrupp AG**

Remarks by Prof. Dr. Schulz  
January 23, 2004

**ThyssenKrupp**



# Annual Stockholders' Meeting

- ➔ **Assessment of the first quarter 2003/2004**
- ➔ Fiscal year 2002/2003
- ➔ Performance of ThyssenKrupp stock
- ➔ Group value-enhancement measures
- ➔ Innovations for sustained market success
- ➔ Outlook



## Assessment of the first quarter 2003/2004

		Q1 2002/2003	Q1 2003/2004
Order intake	€ bn	9.0	9.6
Sales	€ bn	8.7	8.7
Earnings*	€ m	141	over 150

\* before taxes and minority interest

**Good start to fiscal 2003/2004**



# Annual Stockholders' Meeting

- ⇒ Assessment of the first quarter 2003/2004
- ⇒ **Fiscal year 2002/2003**
- ⇒ Performance of ThyssenKrupp stock
- ⇒ Group value-enhancement measures
- ⇒ Innovations for sustained market success
- ⇒ Outlook



## Weak economic parameters

- Performance of economy disappointing worldwide
- Growth forecasts more than halved
- ThyssenKrupp also impacted
- Order intake down to €36 bn
- Sales down to €36.1 bn



## ThyssenKrupp held up well

		2001/2002	2002/2003
Normalized EBT	€ m	419	734
Consolidated net income	€ m	216	512
Earnings per share	€	0.42	1.01
Normalized earnings per share	€	0.48	0.89
Net financial payables	€ bn	4.7	4.2
Gearing	%	57.2	55.5
Dividend per share	€	0.40	0.50*

\* Proposal to Annual Stockholders' Meeting

**Significant improvement in quality of earnings**



# Steel

## ThyssenKrupp Steel

		2001/2002	2002/2003
Order intake	€ m	11,732	11,888
Sales	€ m	11,686	12,016
Earnings *	€ m	167	384
Employees (Sep. 30)		50,184	49,286

\* before taxes and minority interest



## Capital Goods

### ThyssenKrupp Automotive

		2001/2002	2002/2003
Order intake	€ m	6,410	6,271
Sales	€ m	6,337	6,295
Earnings *	€ m	64	188
Employees (Sep. 30)		38,425	41,414

\* before taxes and minority interest





## Capital Goods

### ThyssenKrupp Elevator

		2001/2002	2002/2003
Order intake	€ m	3,615	3,367
Sales	€ m	3,500	3,365
Earnings *	€ m	317	355
Employees (Sep. 30)		28,768	29,689

\* before taxes and minority interest



## Capital Goods

### ThyssenKrupp Technologies

		2001/2002	2002/2003
Order intake	€ m	5,304	4,984
Sales	€ m	5,806	5,382
Earnings *	€ m	112	42
Employees (Sep. 30)		32,781	29,871

\* before taxes and minority interest



## Services

### ThyssenKrupp Services \*

		2001/2002	2002/2003
Order intake	€ m	11,426	11,520
Sales	€ m	11,424	11,276
Earnings **	€ m	124	32
Employees (Sep. 30)		39,675	38,487

\*\* before taxes and minority interest

\* figures from former Materials and Serv segments added together, non-consolidated, unaudited



## Other Group business: Real Estate

		2001/2002	2002/2003
Order intake	€ m	320	345
Sales	€ m	320	345
Earnings *	€ m	80	60
Employees (Sep. 30)		745	638

\* before taxes and minority interest



# Annual Stockholders' Meeting

- ⇒ Assessment of the first quarter 2003/2004
- ⇒ Fiscal year 2002/2003
- ⇒ **Performance of ThyssenKrupp stock**
- ⇒ Group value-enhancement measures
- ⇒ Innovations for sustained market success
- ⇒ Outlook



## Stock performance

(compared with DAX and DJ STOXX, indexed, Sep. 30, 2002 to Sep. 30, 2003)

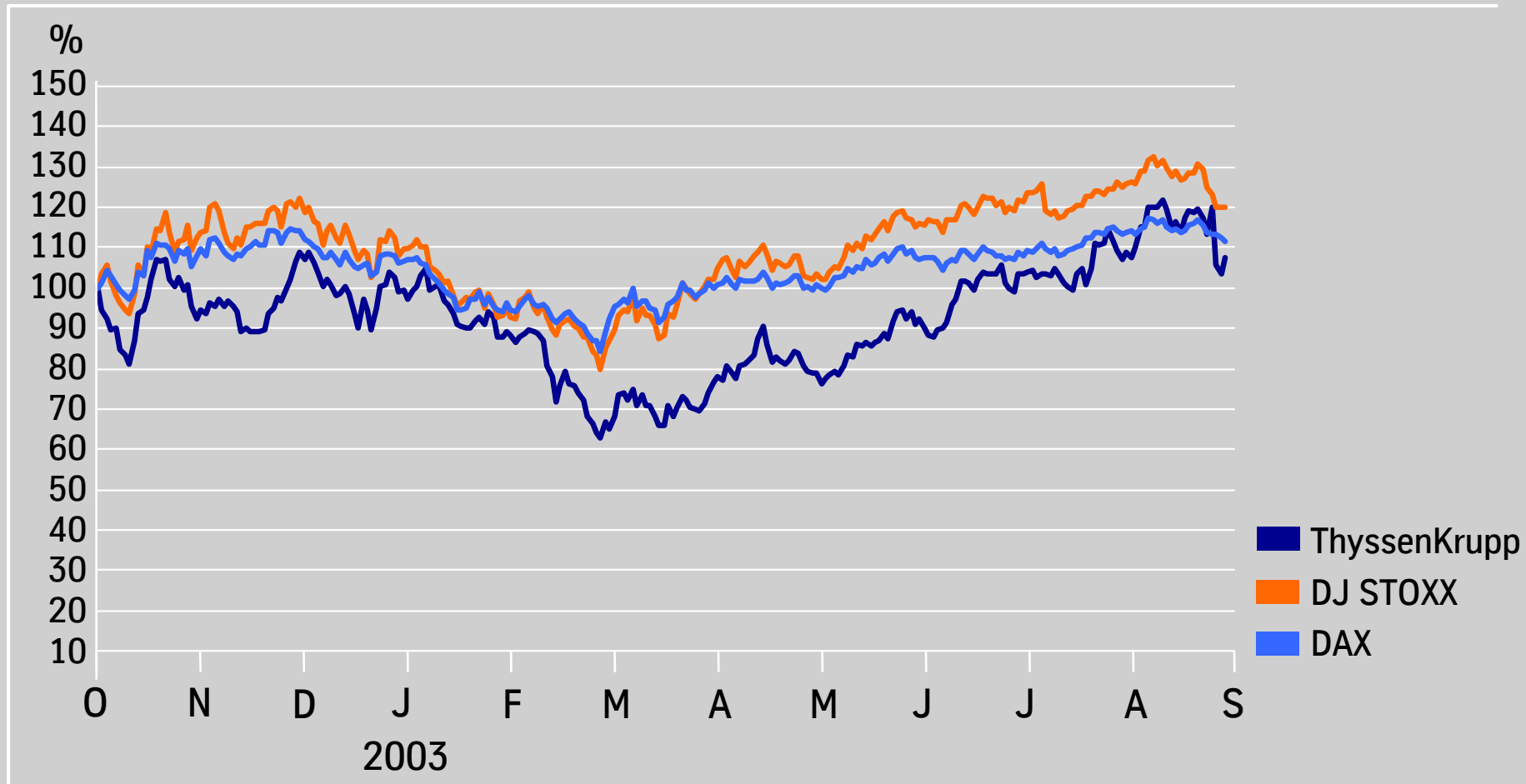

ThyssenKrupp



## Stock performance

(compared with DAX and DJ STOXX, indexed, Oct. 1, 2003 to Jan. 20, 2004)

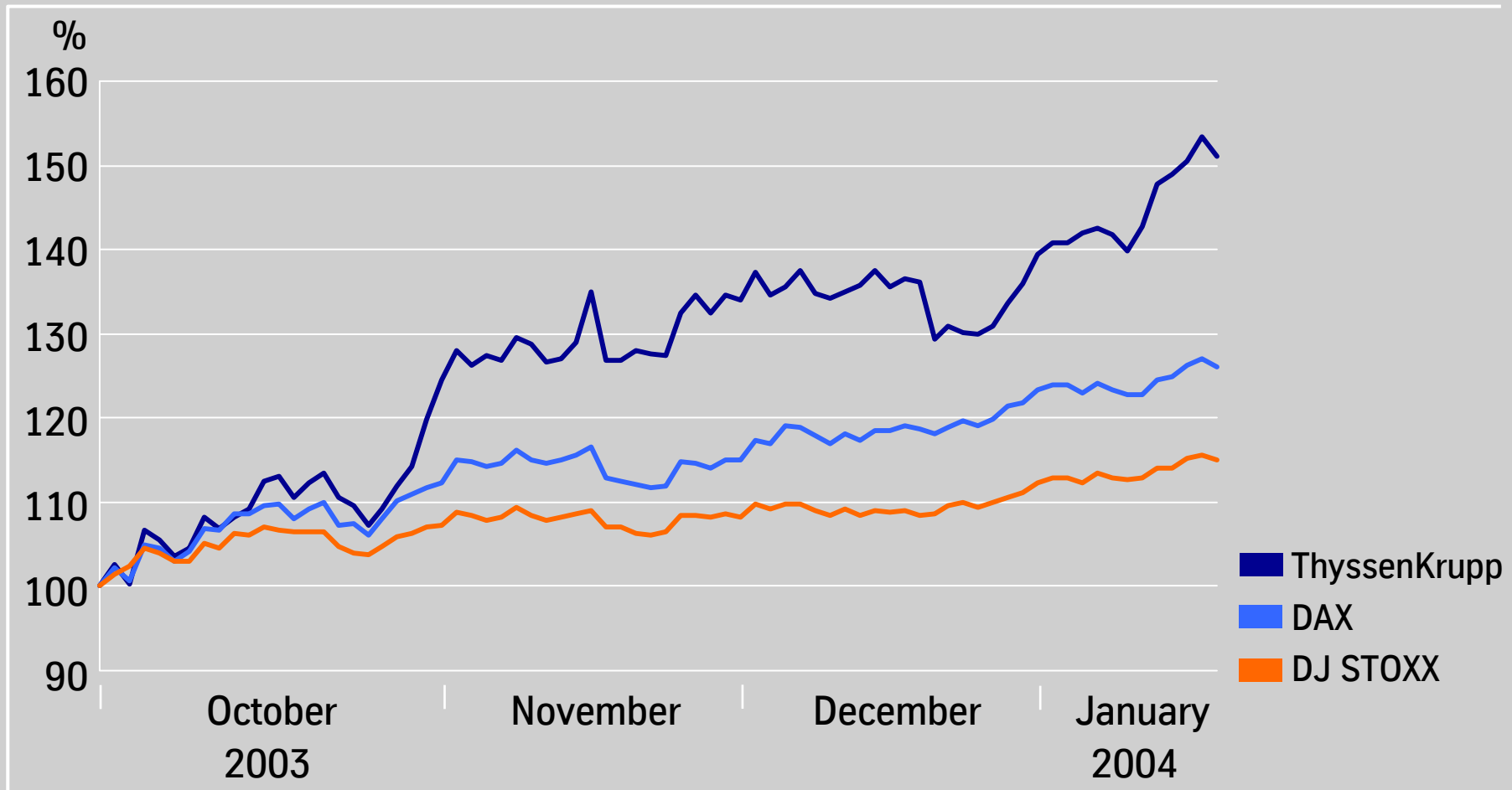

ThyssenKrupp



## Share repurchase

- 16.9 million own shares purchased from IFIC Holding AG in May 2003
- Threat of serious imminent harm averted, sales of up to €8 billion were at risk





## Rating report backs up ThyssenKrupp

- Downgrade by Standard & Poor's despite significantly improved financial situation
- Experts point to lack of uniform standard
- Companies with internally funded pension plans disadvantaged
- ThyssenKrupp has investment grade status at Moody's and Fitch



# Annual Stockholders' Meeting

- ⇒ Assessment of the first quarter 2003/2004
- ⇒ Fiscal year 2002/2003
- ⇒ Performance of ThyssenKrupp stock
- ⇒ **Group value-enhancement measures**
- ⇒ Innovations for sustained market success
- ⇒ Outlook



## Value-enhancement measures

- Further focusing of Group in the areas of Steel, Capital Goods and Services
- Disposal of marginal activities
- Expansion of core activities through organic growth and targeted strategic acquisitions
- **ThyssenKrupp best efficiency-enhancement program**



# Portfolio optimization through focusing

## Structural changes since merger

Sales in billion €

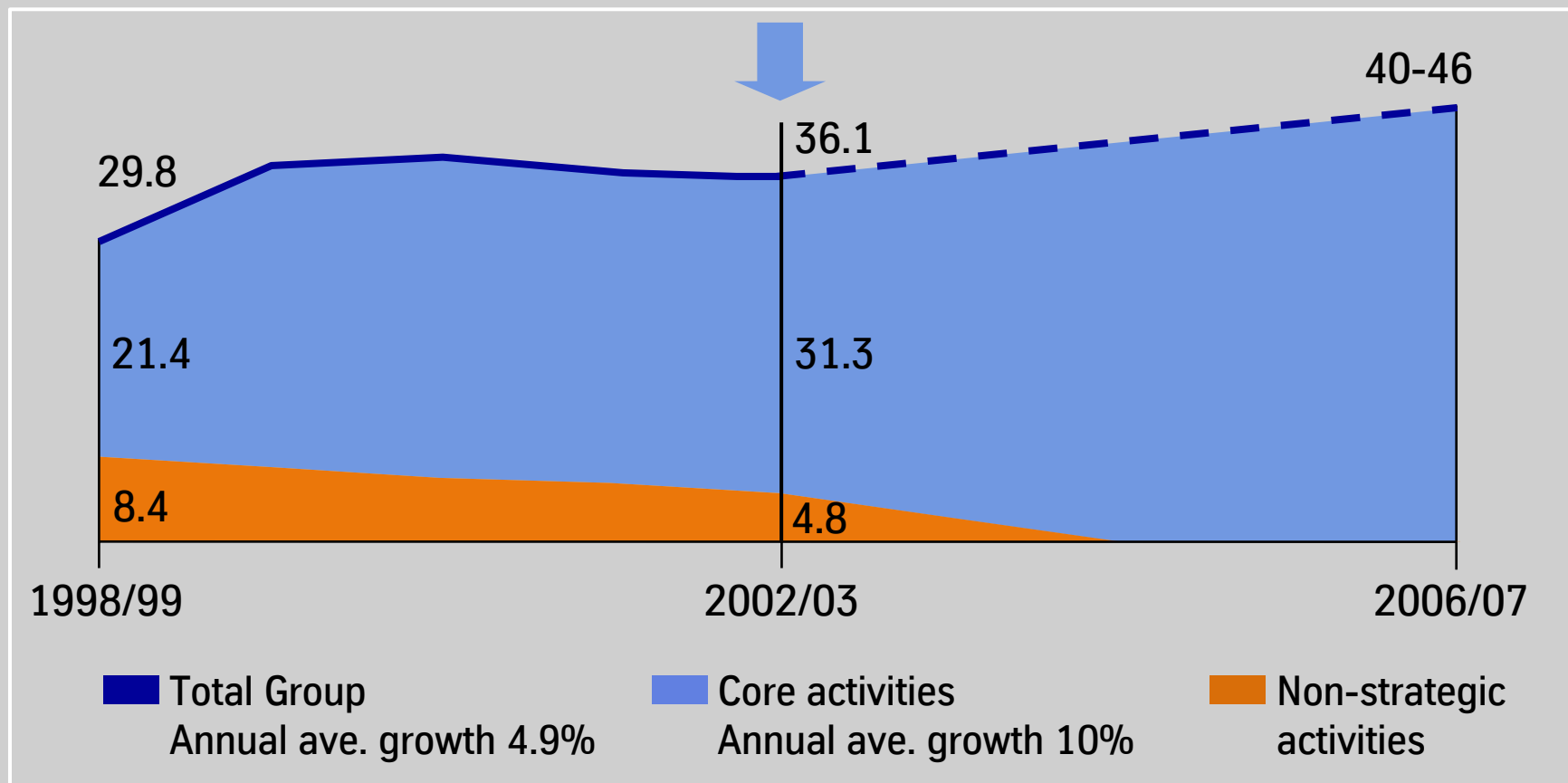

ThyssenKrupp



## Active portfolio management at ThyssenKrupp

Major portfolio changes since merger (as at October 2003)

Sales in million €

**Disposals**  
(Total: €3.6 billion)

**Acquisitions**  
(Total: €5.5 billion)

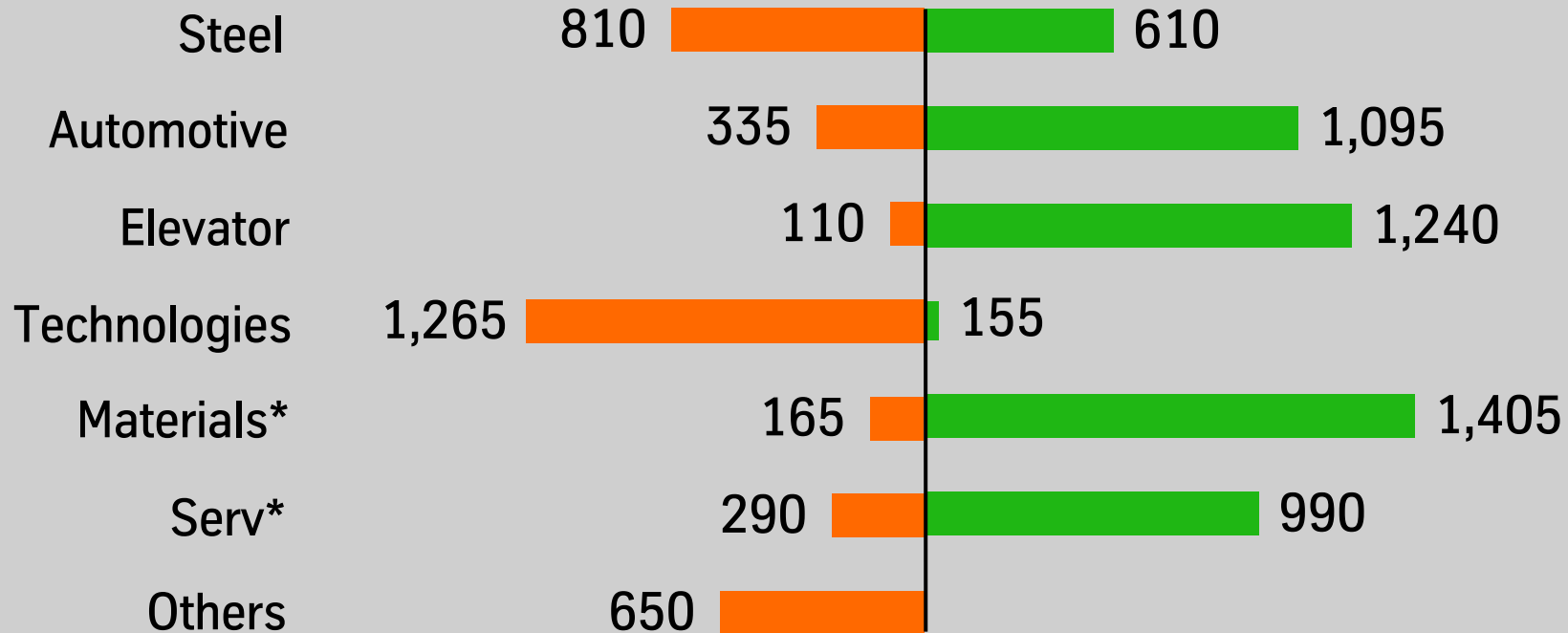

\* Combined into the Services segment on Oct. 1, 2003.



## 39 portfolio changes in 2002/2003 (Oct. 1, 2002 – Sep. 30, 2003)

### Corporate

Böhler Thyssen Schweißtechnik (D)	Disposal
-----------------------------------	----------

### Steel

Galmed (E)	Acquisition
------------	-------------

Quarto plate activities (D) von TKN	Disposal
-------------------------------------	----------

LA.RE. (I)	Disposal
------------	----------

TAD (I)	Acquisition
---------	-------------

Fischer (F)	Gradual closure
-------------	-----------------

Bauelemente Dinslaken (D)	Gradual closure
---------------------------	-----------------

### Automotive

Part of Greening Donald (CAN)	Disposal
-------------------------------	----------

Sofedit (F)	Acquisition
-------------	-------------

Phillips & Temro (USA)	Disposal
------------------------	----------

Philadelphia plant (USA)	Closure
--------------------------	---------

Kendalville (USA)	Closure
-------------------	---------

MB Lenk group (D) **	Acquisition
----------------------	-------------

### Elevator

Lift Service Lublin (PL)	Acquisition
--------------------------	-------------

ECE Elevator (India)	Acquisition
----------------------	-------------

Mahkota (Malaysia)	Acquisition
--------------------	-------------

Ascensores Causi (E)	Acquisition
----------------------	-------------

Bongear/Hang Pak (Hong Kong)	Acquisition
------------------------------	-------------

Britannic Lift Co. (GB)	Acquisition
-------------------------	-------------

Tepper Aufzüge (D)	Acquisition
--------------------	-------------

HABAG (D)	Acquisition
-----------	-------------

Mylau plant (D)	Closure
-----------------	---------

TK Herouth Ltd. Partnership (ISR)	Acquisition
-----------------------------------	-------------

Dong Yang Elevator (South Korea) *	Acquisition
------------------------------------	-------------

\* Closing in 2003/2004    \*\* Signing and Closing in 2003/2004



## 39 portfolio changes in 2002/2003 (Oct. 1, 2002 – Sep. 30, 2003)

### Technologies

Polymer (D)	Disposal
Otto India (India)	Disposal
Stahlbau Berlin (D)	Closure
Henschel (D)	Disposal
Novoferm (D) **	Disposal

### Services

Ferrosta (CZ)	Acquisition
Rodena (DK)	Acquisition
Werkzeugstahl (D)	Disposal
Verder Kunststoffen (NL)	Acquisition
Metal Center Rochester (USA)	Acquisition
TW Metals (USA)	Acquisition
Rodisola (E)	Acquisition
Environmental services (D)	Disposal
Formwork / scaffolds (D)	Disposal
Media Services (D)	Disposal

\*\* Signing and Closing in 2003/2004



# ThyssenKrupp group workforce

## Movements in fiscal 2002/2003

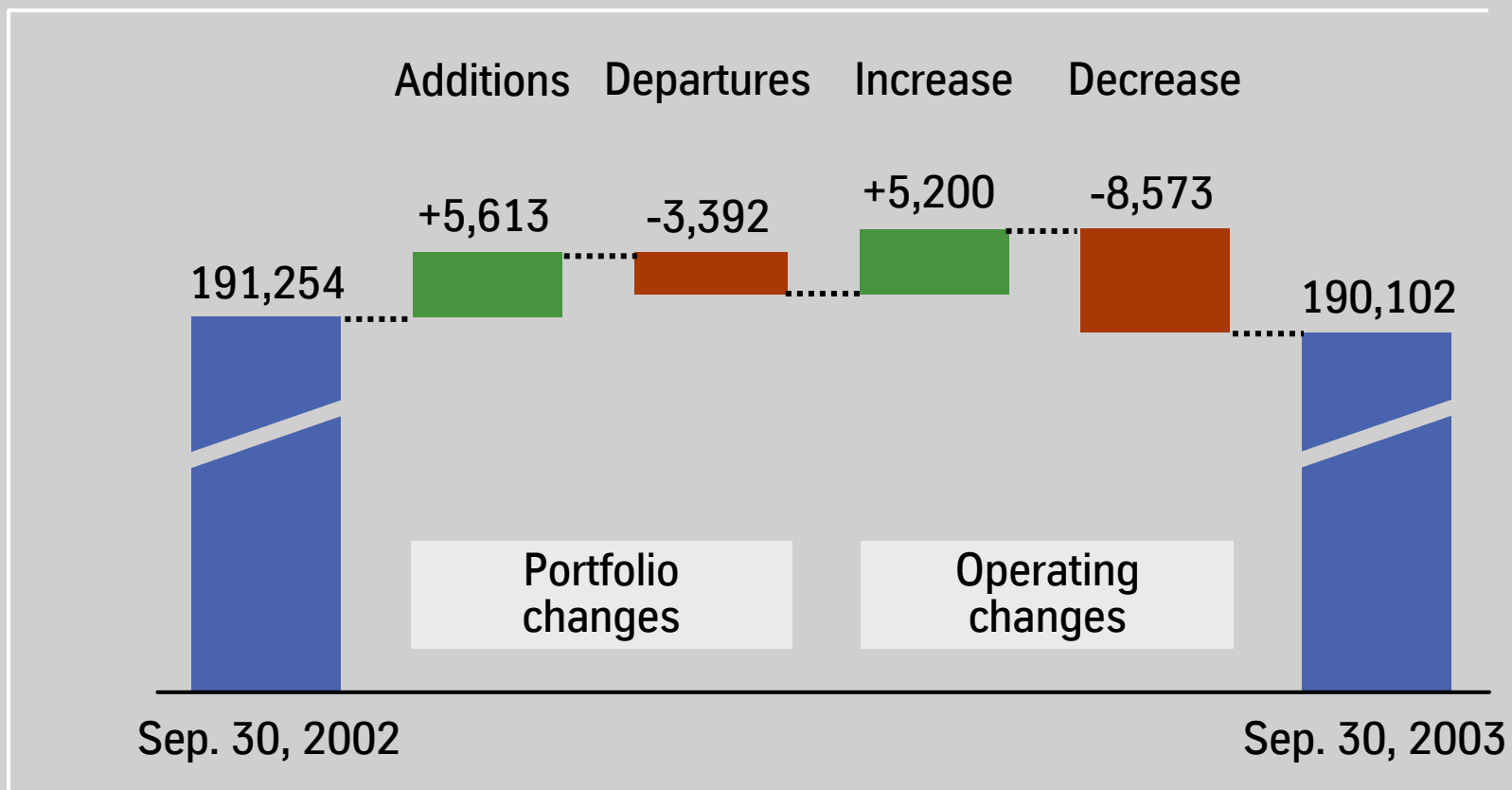



# ThyssenKrupp Group workforce

## Movements during the last 4 fiscal years

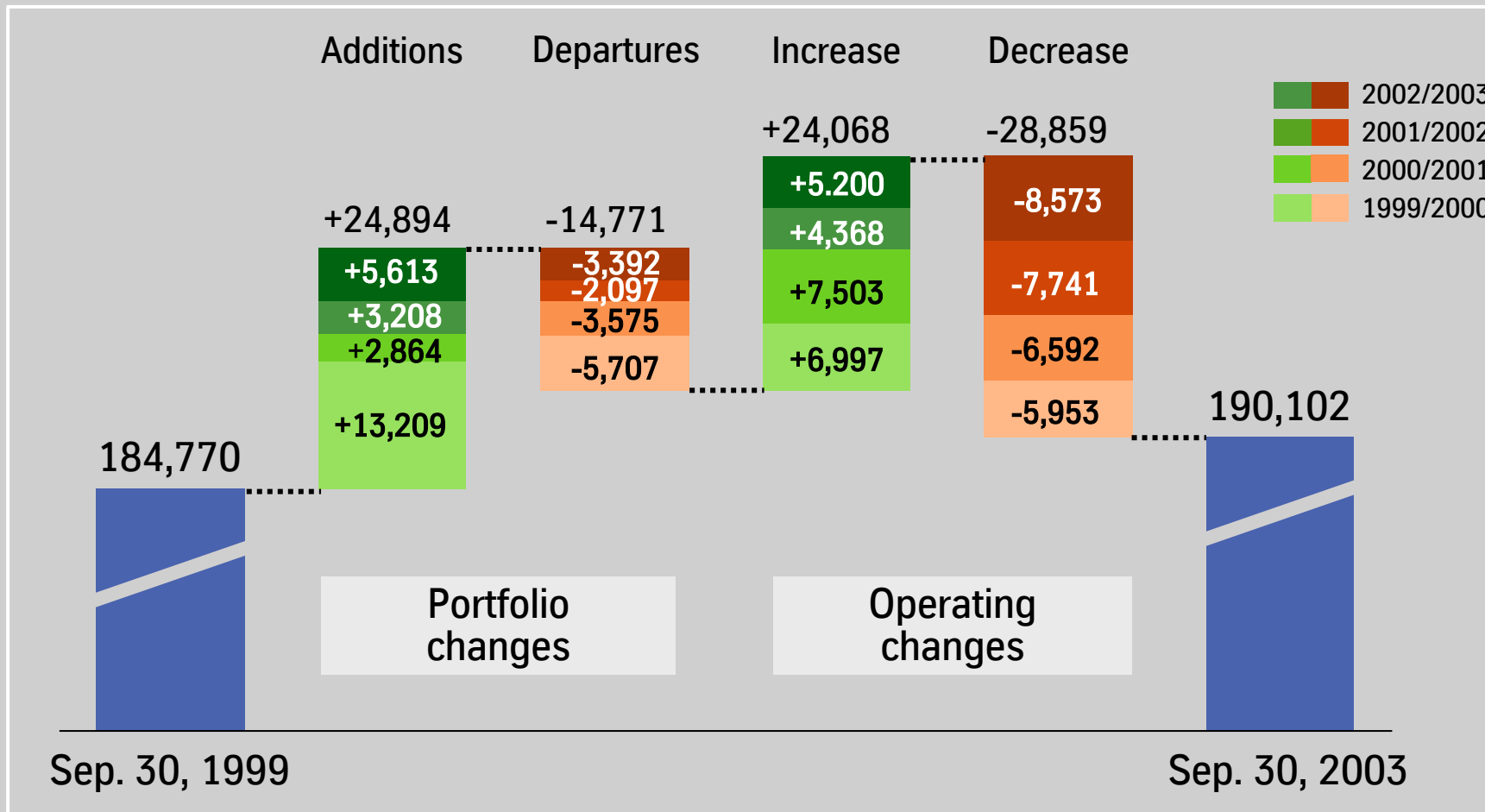

# ThyssenKrupp: Focused industrial group with 3 pillars

Sales in € bn

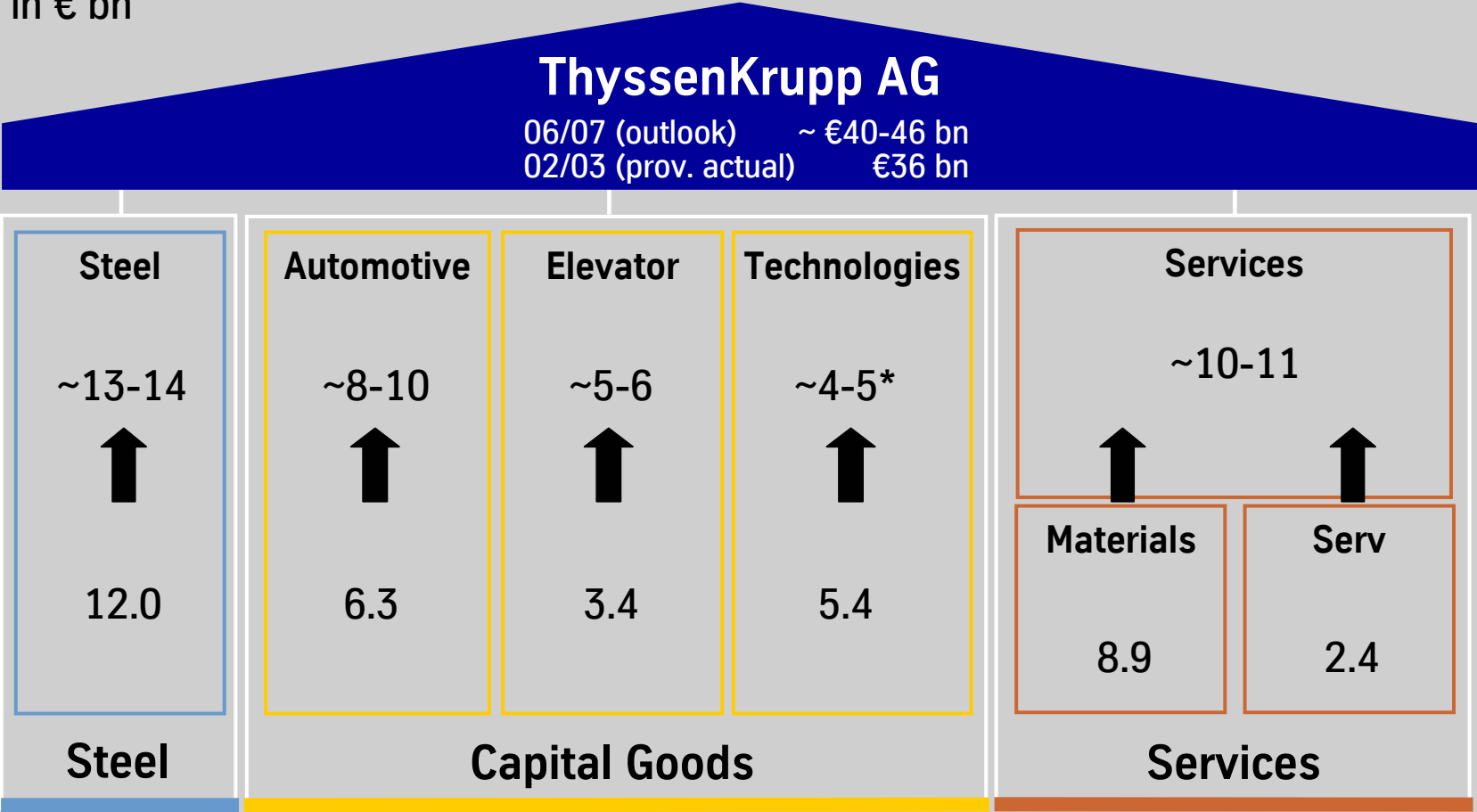

\* Subject to solutions for Shipyards and Plant Technology



# 1,300 new best projects launched in FY 2002/03

## Ramp-up best projects

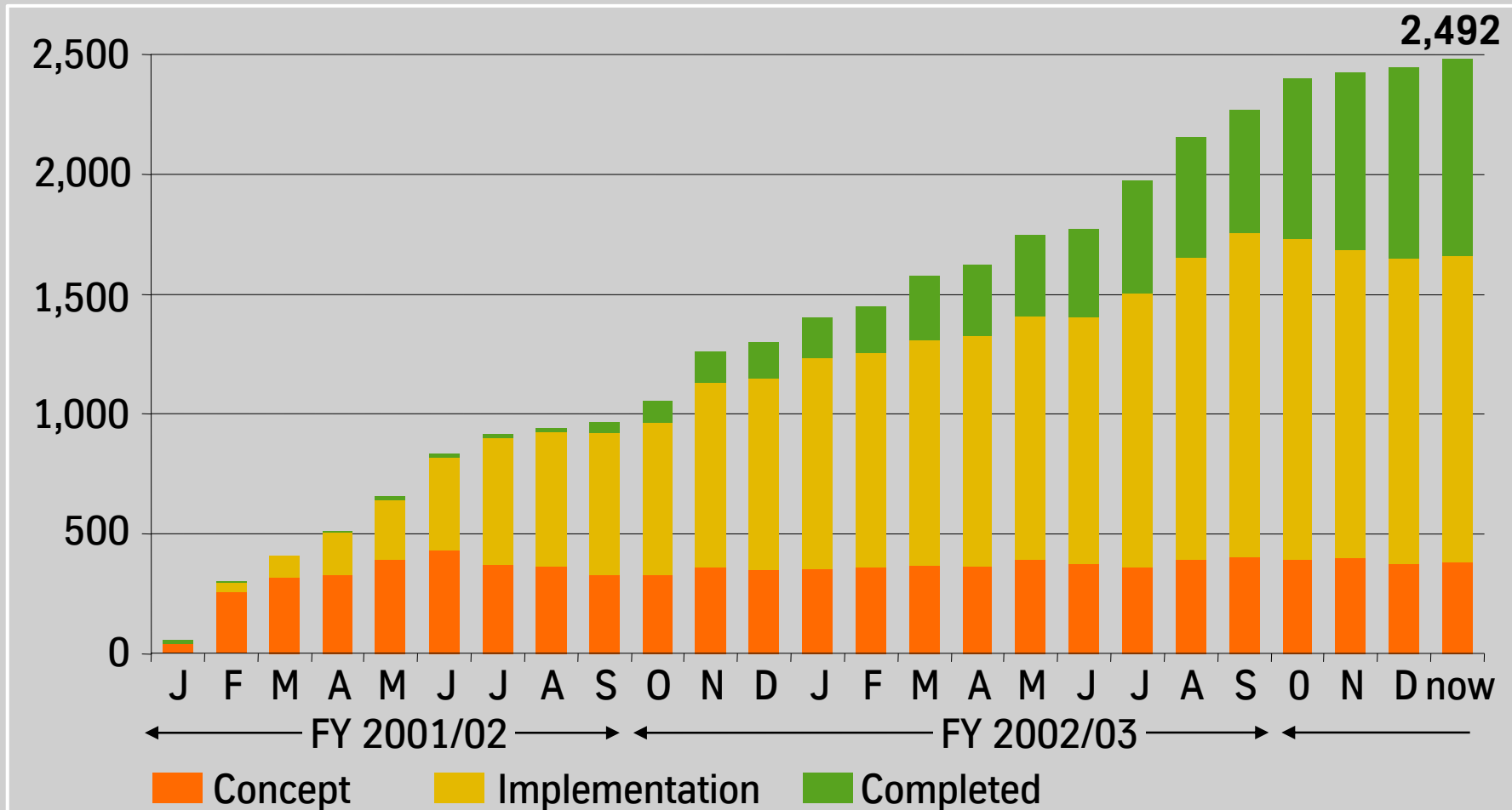

# ThyssenKrupp best projects under way worldwide

## Number of projects by country

910 projects in America

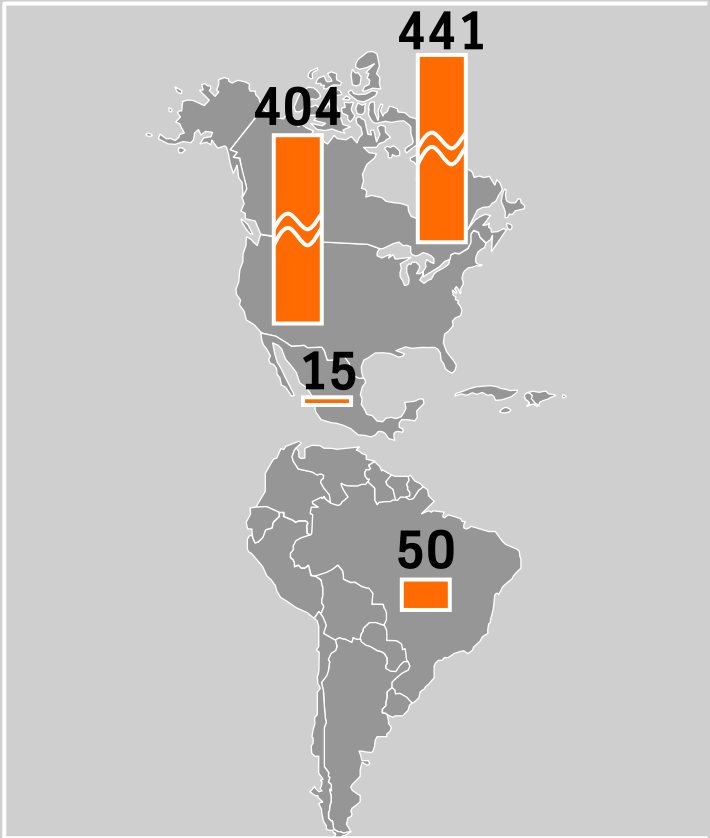

1,467 projects in Europe

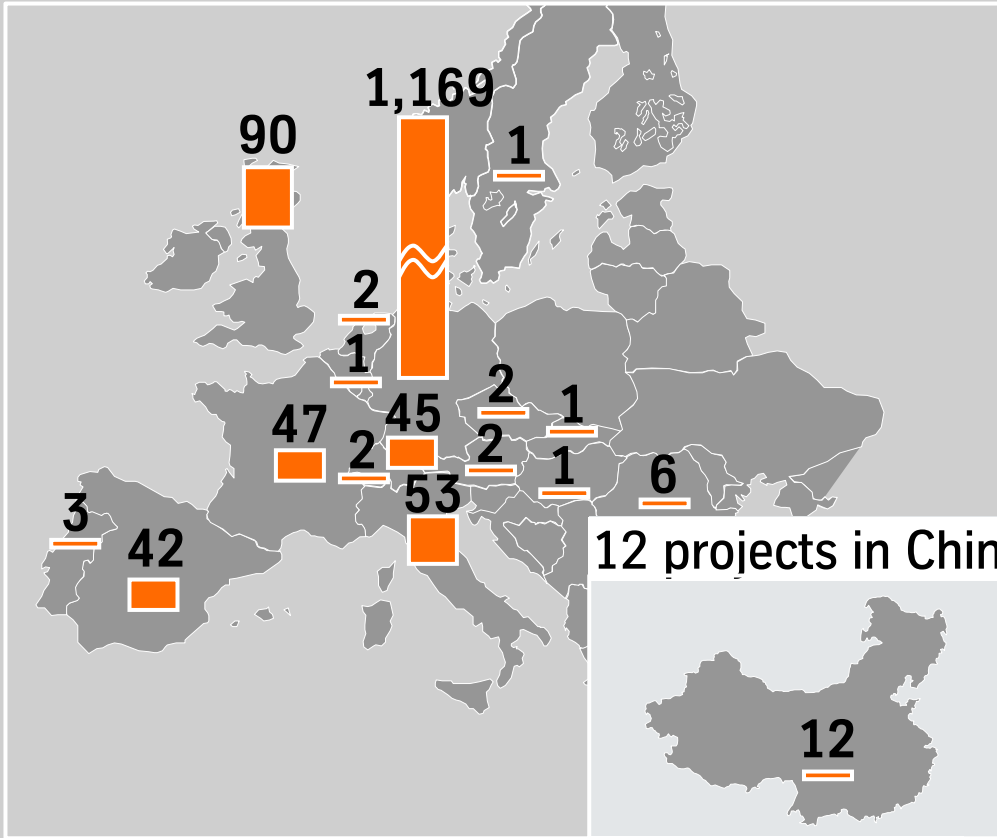

12 projects in China

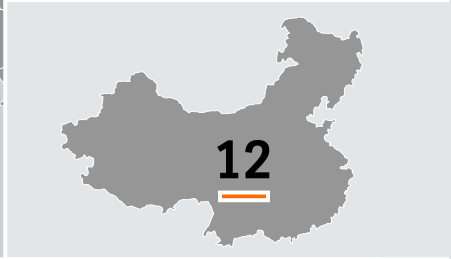

Note: 103 of 2,492 projects are international.



## Launched sales initiative making good progress

Four tools for systematic earnings improvement

Customer penetration

I. Increase customer penetration

⇒ Tool: *"Customer"*

New market segments

II. Identify attractive market segments

⇒ Tool: *"Market"*

Price or contrib. margin  
products

III. Optimum price realization

⇒ Tool: *"Pricing"*

Product mix

IV. Optimum product portfolio

⇒ Tool: *"Portfolio"*



# Annual Stockholders' Meeting

- ⇒ Assessment of the first quarter 2003/2004
- ⇒ Fiscal year 2002/2003
- ⇒ Performance of ThyssenKrupp stock
- ⇒ Group value-enhancement measures
- ⇒ **Innovations for sustained market success**
- ⇒ Outlook



# ThyssenKrupp Steel

## Steel – a material with a future

- Providing impetus for innovative steel solutions
- NSB NewSteelBody
  - systematically weight-optimized steel body-in-white
  - 24% lighter than benchmark vehicle (minivan)
  - crash performance equivalent or better

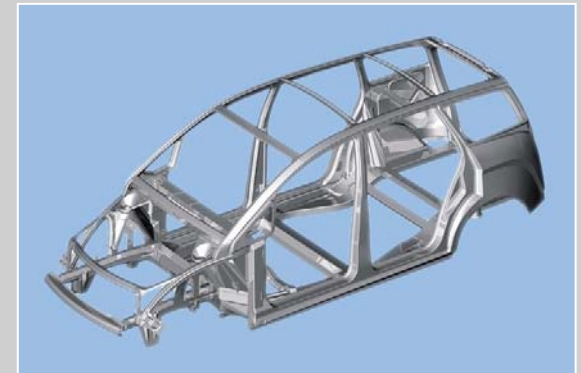

**Showing vision. ThyssenKrupp**

# ThyssenKrupp Elevator

## Taking innovative technologies to the top

- TWIN order: Groundbreaking innovation
  - Implemented for the first time by ThyssenKrupp
  - Transportation of up to 40% more passengers
  - Requires 25% less building space
  - Multi-stage safety concept

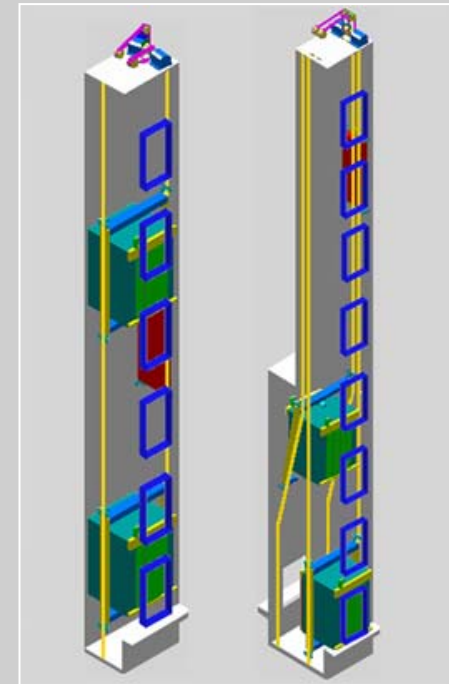

Going up. ThyssenKrupp



# Annual Stockholders' Meeting

- ⇒ Assessment of the first quarter 2003/2004
- ⇒ Fiscal year 2002/2003
- ⇒ Performance of ThyssenKrupp stock
- ⇒ Group value-enhancement measures
- ⇒ Innovations for sustained market success

⇒ **Outlook**



## Outlook: 2004 economy

Economic environment starting to improve. Slight recovery in demand on markets important to ThyssenKrupp :

- **Steel:** Consumer-driven demand increase in 2004
- **Automobiles:** Higher output forecast
- **Mech. engineering:** Slight production increase
- **Construction:** No sustainable recovery in sight for German construction sector  
Prospects for CIS, CEE and Asia more favorable



## ThyssenKrupp in fiscal 2003/2004

### Improved performance expected

- Sales in region of €38 billion planned for 2003/2004
- Aiming for significant increase in EBT
- Dividend again based on normalized earnings per share
- Target of €1.5 bn to be achieved as quickly as possible

**Earnings target realistically reflects potential of ThyssenKrupp**

